

# William A. McElhiney

## Distinguished Lecturer Series

### Well Technology

Made possible by a grant from Franklin Electric Company to the  
National Ground Water Research and Educational Foundation





# NGWREF McElhiney Lecture Series



To foster professional excellence in water well technology, the National Ground Water Research and Educational Foundation has established the William A. McElhiney Distinguished Lecture Series in Water Well Technology.

Initiated in 2000, the lecture series honors William A. McElhiney, who was the founding president of the National Ground Water Association in 1948, and a ground water contractor and civil engineer from Brookfield, Illinois.





# NGWREF McElhiney Lecture Series

"McElhiney and the other founders of the Association saw several primary functions for the new national group," explains Foundation Executive Director Kevin McCray, "including serving as a clearinghouse for information and its dissemination, serving as an intermediary in coordinating advances occurring in different parts of the country, and serving as a place to bring contractors together so that they might have a working knowledge of contracting from all parts of the nation. NGWREF's McElhiney Lecture series promotes and perpetuates those original aims."





# NGWREF McElhiney Lecture Series

Annually, a panel of ground water contractors invites an outstanding ground water contracting professional to share his or her work with the industry. Individuals may nominate themselves or others they believe to be qualified to serve as the NGWA McElhiney distinguished lecturer.





# NGWREF McElhiney Lecture Series

Effective May 2005, Franklin Electric Co., the world's largest manufacturer of submersible electric motors, has agreed to underwrite the next three years of this lecture series for presentations to organized groups of contractors and other qualified and interested parties. Meetings and conventions of state and regional associations are eligible. Foreign associations of ground water contractors, academic institutions teaching water well technology, gatherings of water well regulators, and other bodies with a direct and identifiable interest in water well design and construction are eligible as well.





# NGWREF McElhiney Lecture Series

*2010 Lecturer*

**Mike Mehmert, B.S.**

Director of Sales and Marketing-Well Products at Johnson Screens,  
a Weatherford Company





# NGWREF McElhiney Lecture Series

## You Drill a Hole – You Develop a Well





# Why Well Development

## Well Life Cycle

Construct it.

Use it. (Maintenance & Rehab)

Abandon it.

### Construction

- Design
- Installation
- Development
- Testing







# Discussion Topics

- What it is?
- Why do we do it?
- What impacts it?
- How we do it?
- When are we done?
- What are the benefits?





# What is development?

Intentional application of select mechanical techniques – often with chemistry - to remove drilling damage and restore or enhance near well hydraulic characteristics.





# Why We Do It?

## ❑ #1 - Drilling changes things.

- ❑ Disturbs natural conditions
- ❑ Introduces fines & fluids.
- ❑ Alters hydraulic conditions.





# Why We Do It?

## ❑ #2 - Achieve original design expectations.

- ❑ Sand control (formation, pack stabilization).
- ❑ Enhance yield, maximize specific capacity.
- ❑ Assure expected sample quality.

## ❑ #3 - Want to deliver a quality product.

< efficient well >





# Well Efficiency

$$E_w = \frac{\textit{drawdown}_T}{\textit{drawdown}_A}$$



Drilling  
Method

Geology

Drilling  
Fluids

# What effects well development?

expertise

contract

Murphy's  
Law

Type  
Screen

Type  
Completion



# Drilling Method

- Rotary
- Casing advance
- Cable Tool
- Auger
  
- All methods, crush, rearrange, fill voids, alter and typically lower natural hydraulic conductivity*



# Rotary



Straight  
Reverse

Air, Foam, Mud





# Specialized Rotary Methods

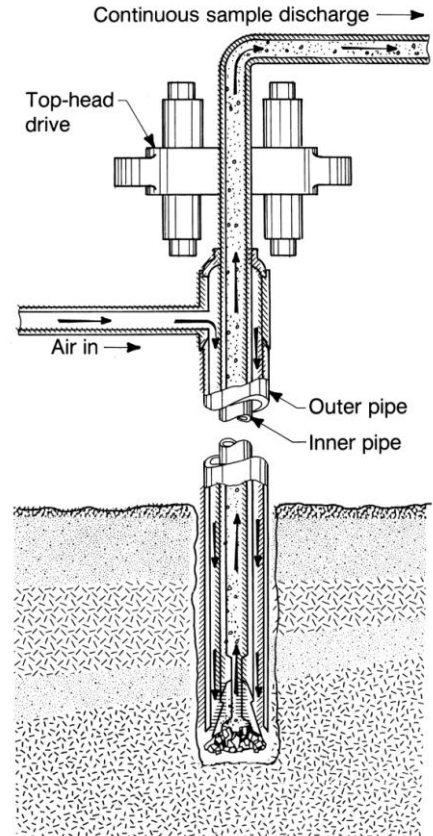
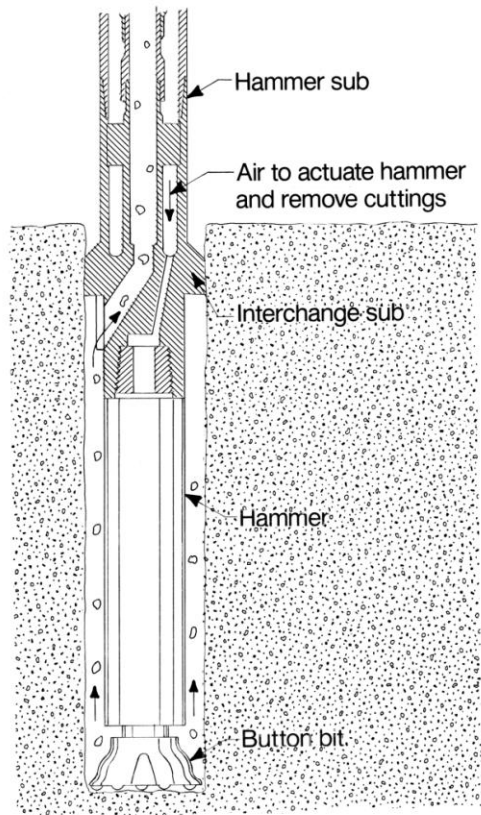

# Specialized Rotary

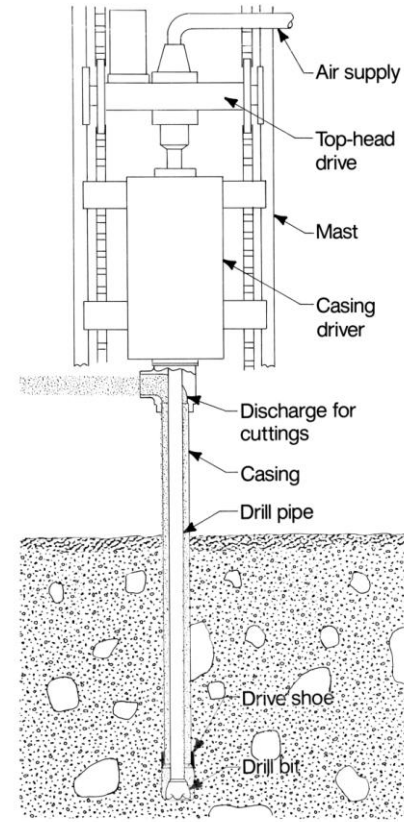

# Auger



# Aquifer Geology

- Determine Completion
  - Open hole
  - Natural develop
  - Artificial pack
- Method
- Time spent

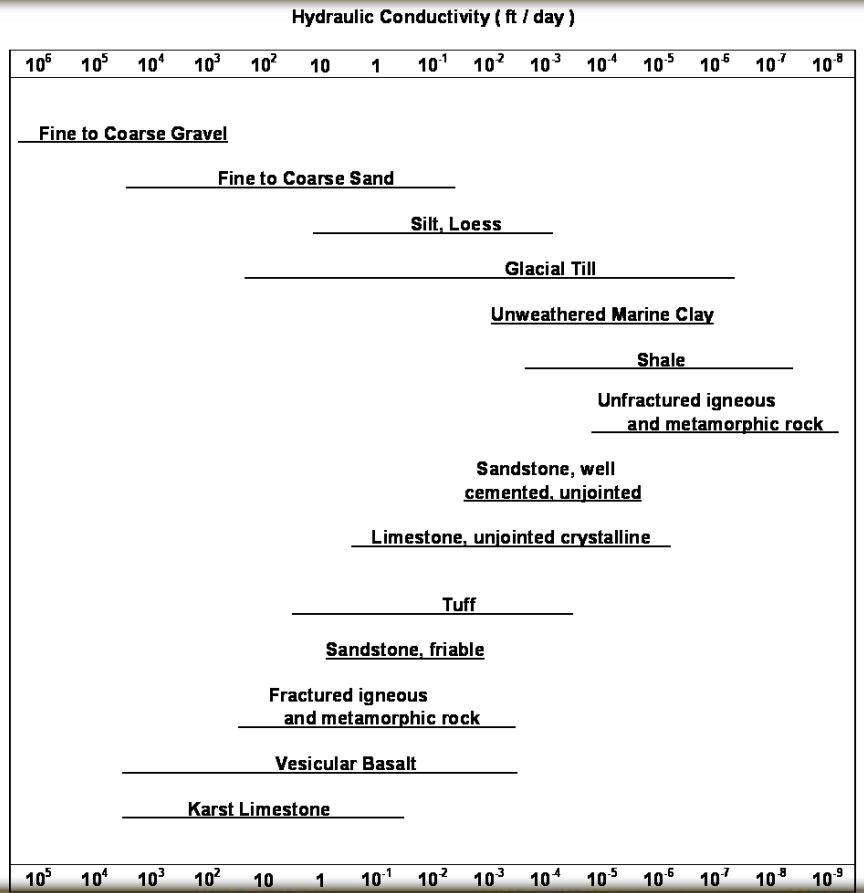

# Drilling Fluids

## □ Type

- Organic/Synthetic Polymers
- Natural Clays, Bentonite
- Air/foam



# Fluids Management

- Control Solids, Viscosity, Density
- Timely break-back
- Over balanced
  - Excess wellbore pressure
- Under balanced
  - Reduced wellbore pressure
  - Increased penetration & bitlife
  - Less formation damage
  - Less development time

skill

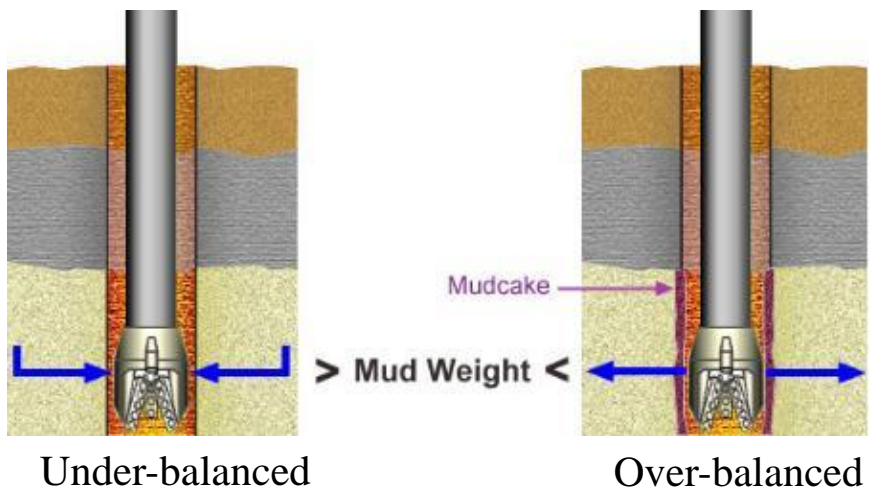

# Screen Type

- ❑ Dictates slot geometry which affects energy transfer to and from the formation.
- ❑ Especially important as formation hydraulic conductivity decreases.
- ❑ Development method should compliment the screen design to maximize efficiency.

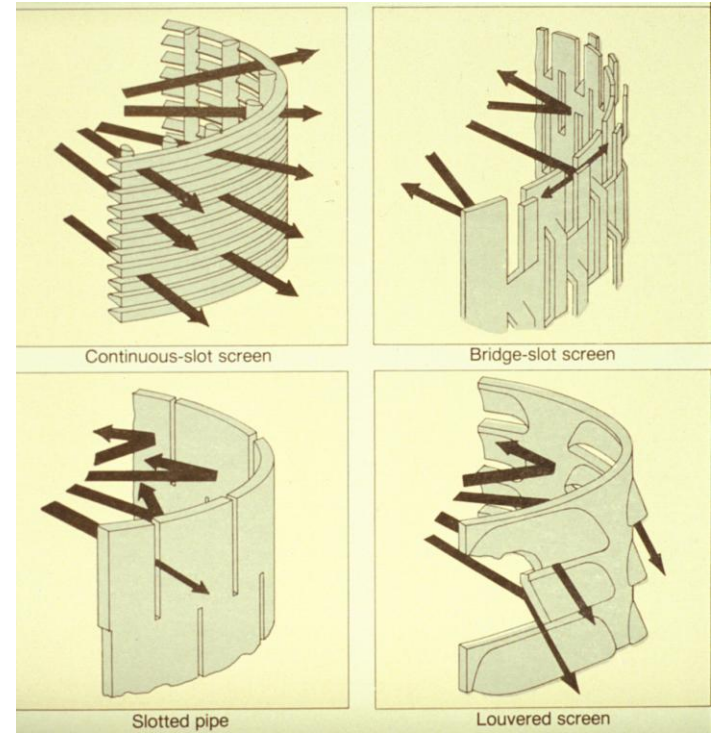

# Screen Type Open Area

- ❑ The higher the open area the less resistance to flow and the greater the access.
- ❑ Especially effective w/ jetting techniques.
- ❑ Improves success in low permeability situations
- ❑ Can save time.
- ❑ *A real plus years later for rehab!*

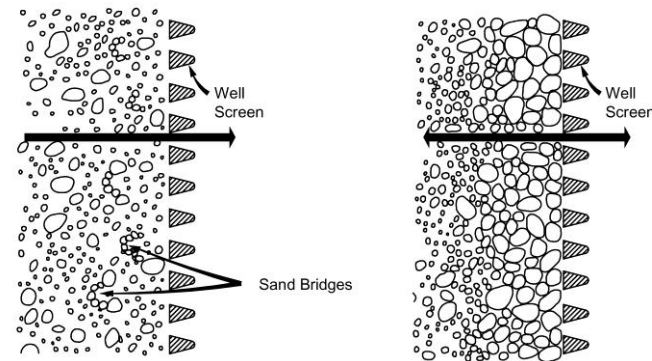



# Type Completion

- Open hole
- Natural pack
- Artificial pack
- Pre-Pack





# Artificial Pack

## Thickness

- Approximately 3 – 4 inches is optimal
- Thicker filter pack requires more development
- Thin filter pack (< 1 inch) is conventionally difficult to place and fines can pass through

## Placement

- Uniform
- Segregation
- Volume

## Pre-packs (typically ½ - 1 inch)

- Ideal where the formation will readily collapse around the screen.



# Pack Thickness

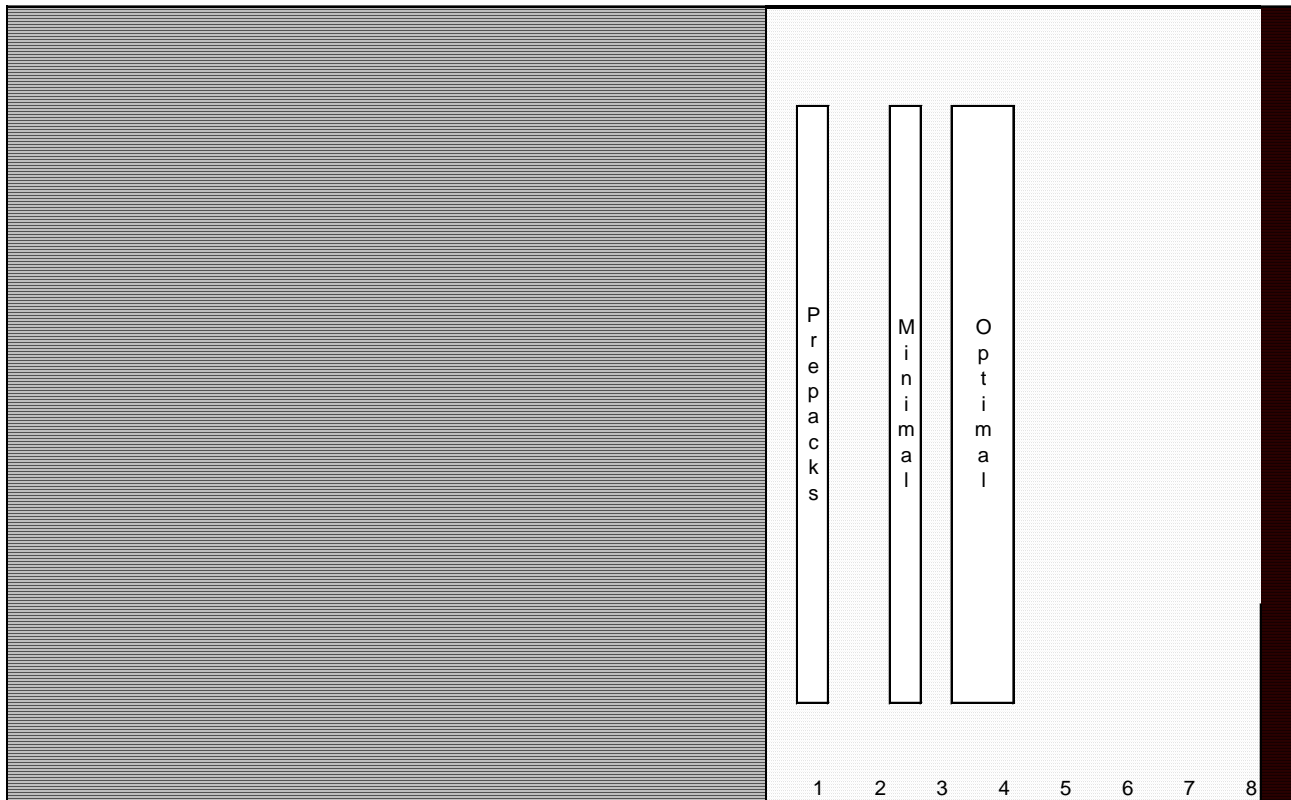

# PrePack Screens

Properly sized filter pack.  
Uniform placement assured.  
Borehole collapse after  
development.

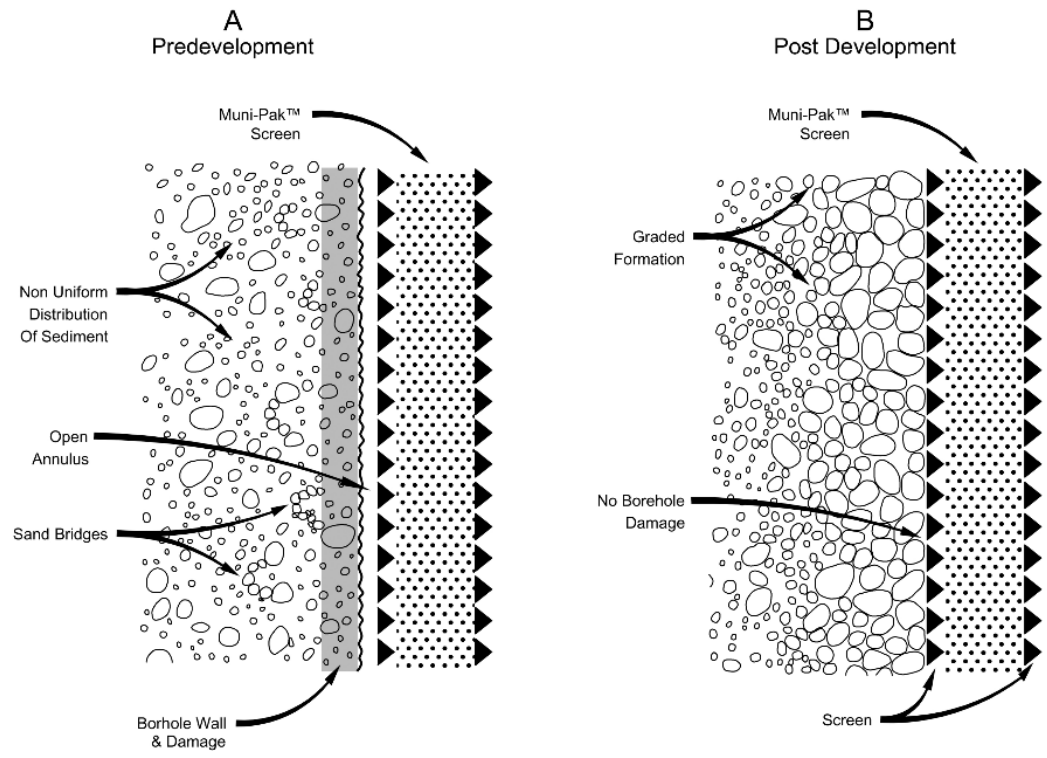

## Murphy's Law

Anything ever go wrong?



# Common Scenario

- ❑ Conventional mud rotary
  - ❑ Filter cake
  - ❑ Invaded zone
  - ❑ Fill void spaces.
  - ❑ Decrease hydraulic conductivity.
- ❑ Breakdowns can increase the demands on development!

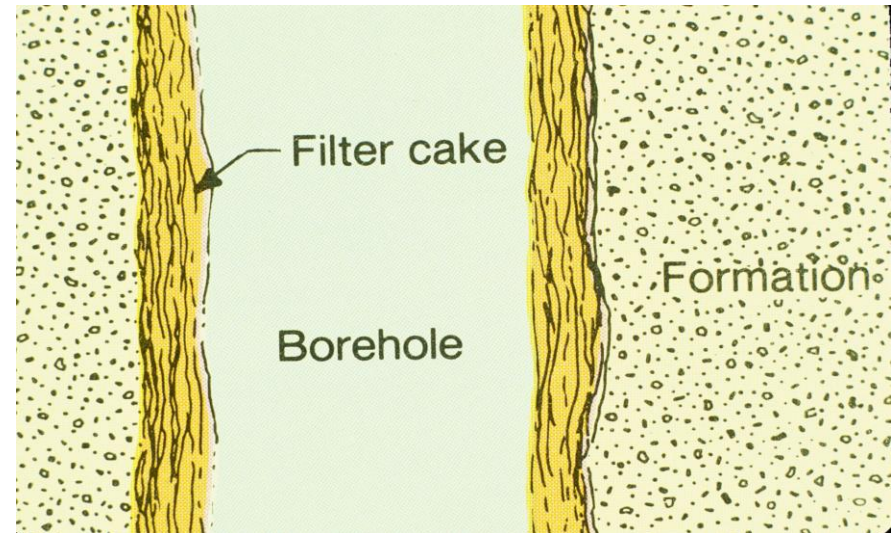

# Contract

## Development Method

Method should match completion

Screen type

## Development Time

Criteria for being done?

Payment?



# How Do We Do It?





# Techniques to Agitate & Extract

## Development Techniques

- Bailing
- Pumping
- Surging
- Airlift
- Jetting

## Chemical Additives

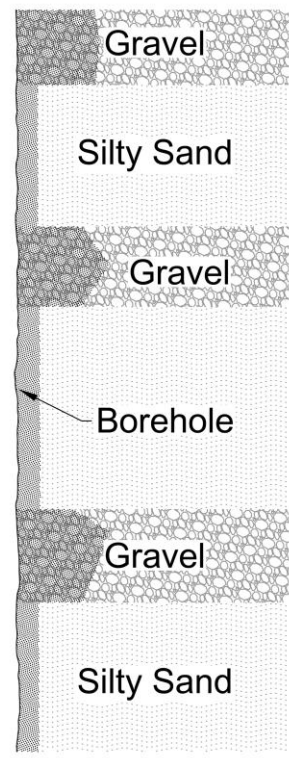
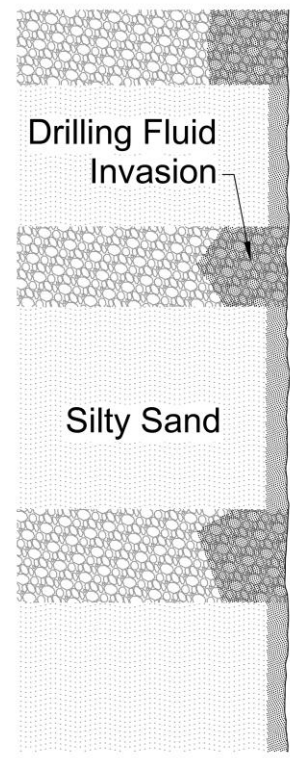



# Bailing

- ❑ Typically an initial step (especially in small diameter).
- ❑ Requires no additional power sources.
- ❑ Low yield well, gives indication of production (via recovery).
- ❑ Bailer size can aid surging action.



# Pumping

- ❑ Most fundamental
- ❑ Typically at rates  $>$  design production.
- ❑ One-way flow unless backwash.
- ❑ Tends to develop most permeable zones.
- ❑ Temporary pump needed.
- ❑ Often a final step / pump test



# Surging

- ❑ Forcing water in and out of formation
  - ❑ materials & tolerances important
- ❑ Force exerted depends on
  - ❑ length of stroke
  - ❑ velocity of tool
- ❑ Bailer works in SM Dia

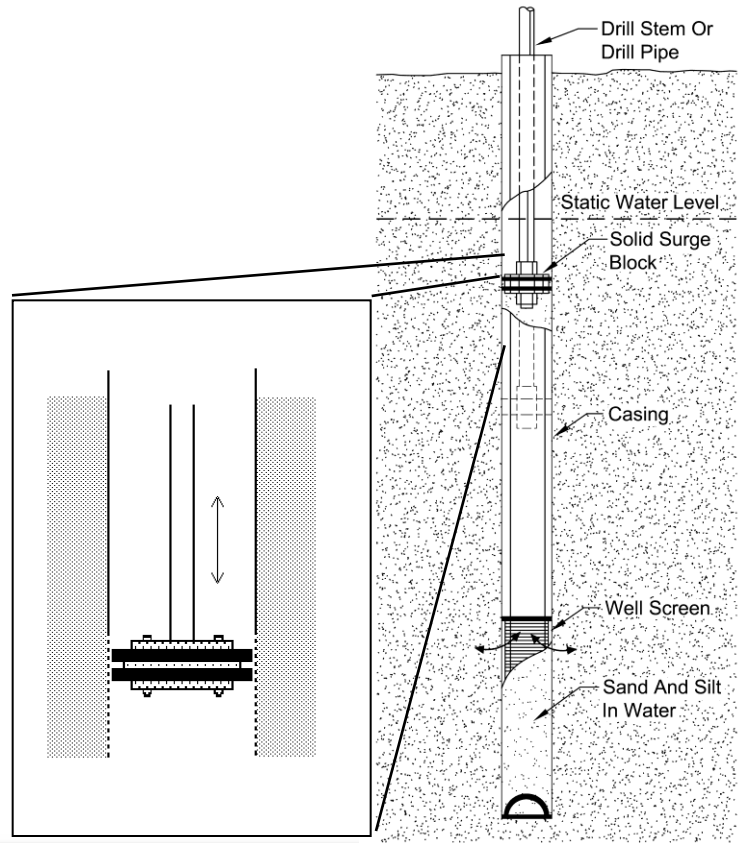

# Mechanical Surging

- ❑ Higher risk of plugging in formations w/clay streaks.
- ❑ Swabbing may cause large differential pressures – use caution with PVC or slot < 0.010 inch



# Pneumatic Surging

Step 1 - Setup.

Dosage includes entire static column + displacement dilution.

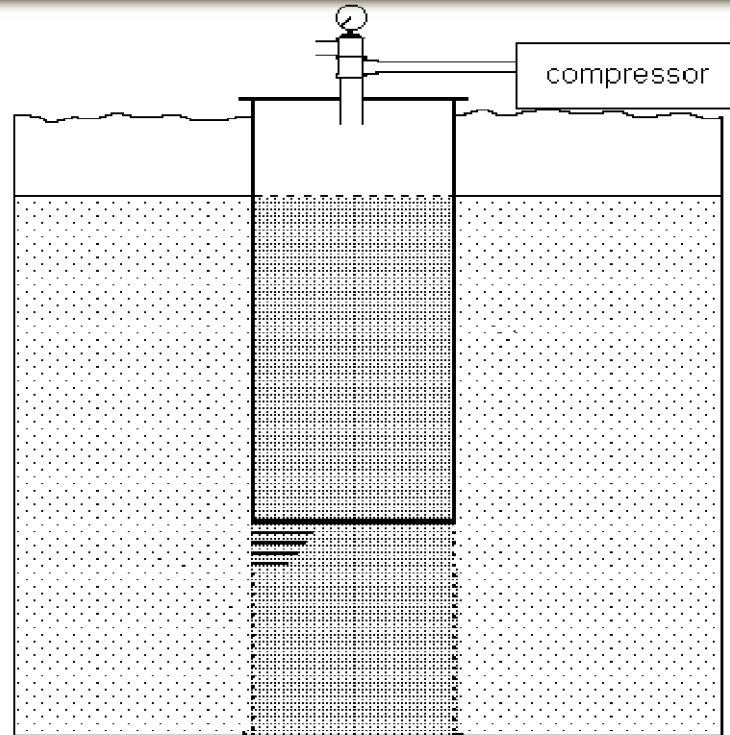

**Chemicals are mixed thoroughly in static column.**

**Air-tight seal is secured to well head.**



# Pneumatic Surging

## Step 2 - Displacement

Depending on compressor size this can usually be done in 30 - 60 seconds.

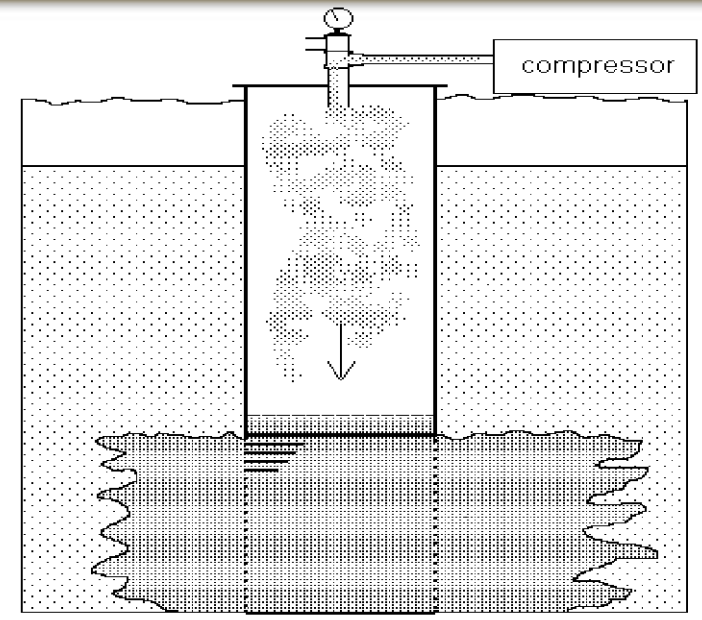

Outlet valve is closed, well is charged with air to drive static level down to within 5 - 10 ft of the top of the screen.

Pressure necessary is found by:

$$PSI = \frac{\text{(Depth to Top Screen - SWL)}}{2.31}$$



# Pneumatic Surging

## Step 3 - Evacuation

Integrity of the wellhead seal is very important for obvious safety reasons.

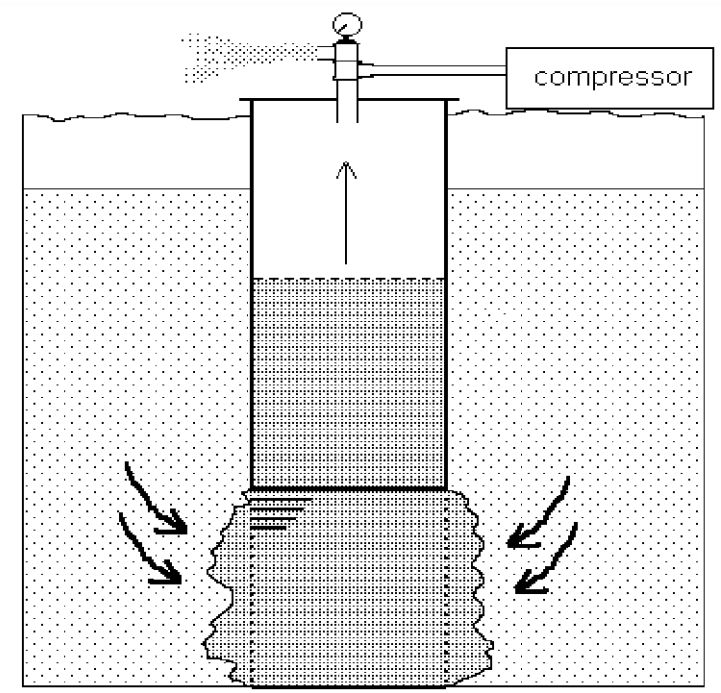

**Release of pressure allows fluid to rush back into the well. Result is excellent agitation in the effected zone.**

**Cycles should be repeated frequently and pH checked periodically to determine level of activity.**





# Pump-To-Tank Surging

- ❑ Manual or Automatic cycling
- ❑ Facilitates monitoring of chemical activity
- ❑ Chemicals added easily
- ❑ Fluid motion good for reactivity.
- ❑ Use of packers to isolate zones

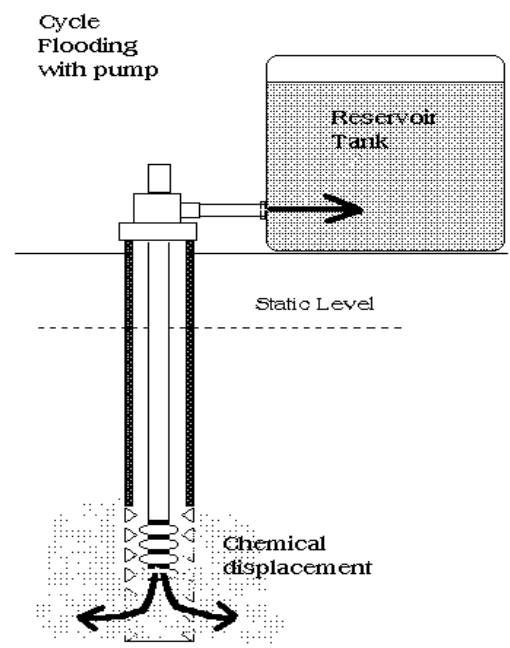

# Conventional Jetting

- ❑ Effective in highly stratified aquifer
- ❑ Good for mud cake break up
- ❑ Can be done with air or water
- ❑ Most effective with simultaneous pumping.

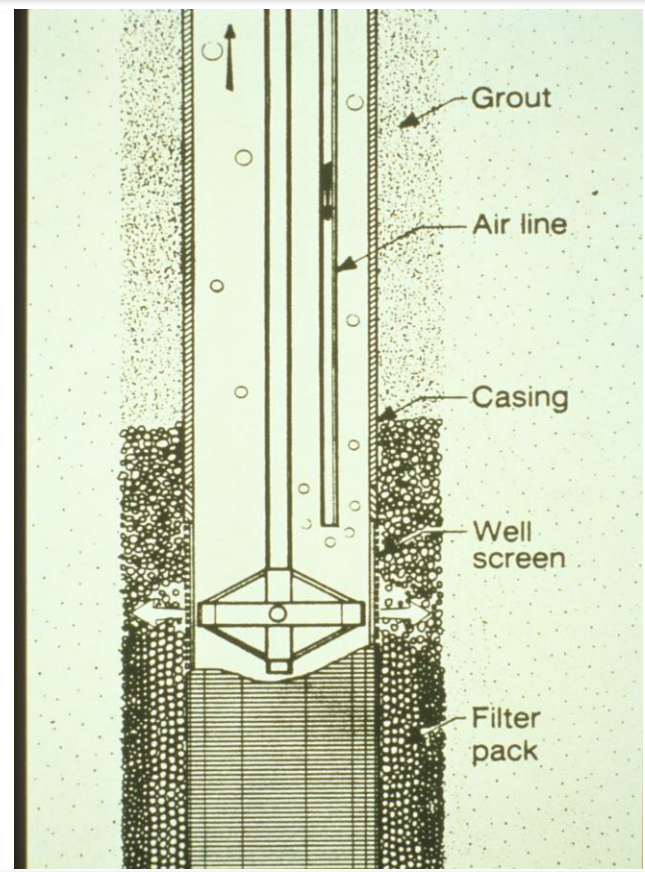

# Conventional Jetting Tool

- ❑ Minimum nozzle velocity of 100 fps, optimum 150 -300 fps.
- ❑ Jetting pressures of 100 to 300 psi.
- ❑ Easy to include chemicals
- ❑ Best application in wire-wrap screens

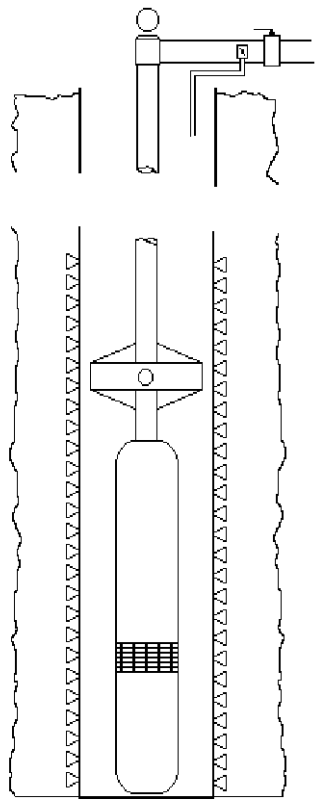

# Higher Pressure Tools

- ❑ Nozzles evenly spaced to hydraulically balance tool during operation.
- ❑ OD tool as close to ID of screen as possible (< 1 in away).
- ❑ Water should contain no sediment.
- ❑ Nozzles made of abrasion resistant material.



Courtesy Baski, Inc.





# Impulse generator Hydropuls®

- Widely used in rehabilitation.
- Hydraulic “shock wave” by sudden expansion of highly compressed gas.
- Loosens fines, debris.
- Used in most completion materials (steel, pvc, fiberglass).



# Impulse generator Airburst®

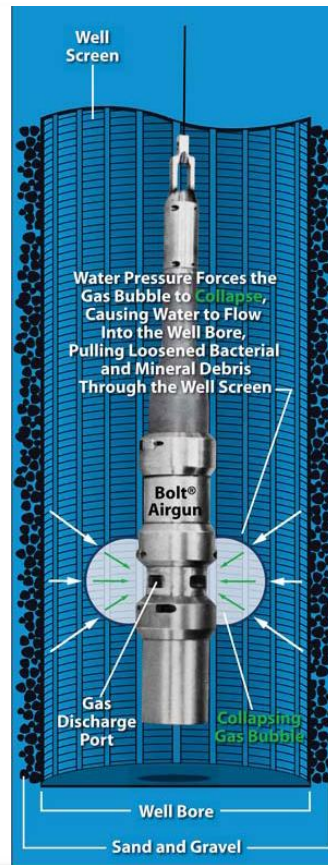
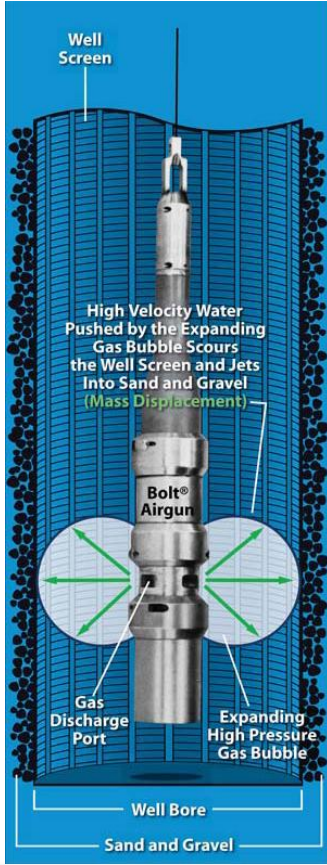
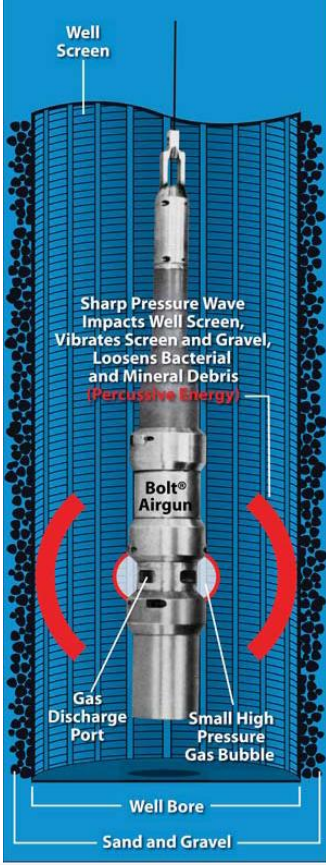



# High Pressure Jetting MuniPak™

- ❑ Up to 10,000 psi.
- ❑ 1,000 ft/sec
- ❑ Effective in prepack
- ❑ Effective workover.
- ❑ Cautions:
  - ❑ Keep tool moving
  - ❑ No sediment circulating



AC Schultes 2006



# Isolation Tools

- Focus energy.
- Saves trip time.
- Combine techniques
- Chemical injection

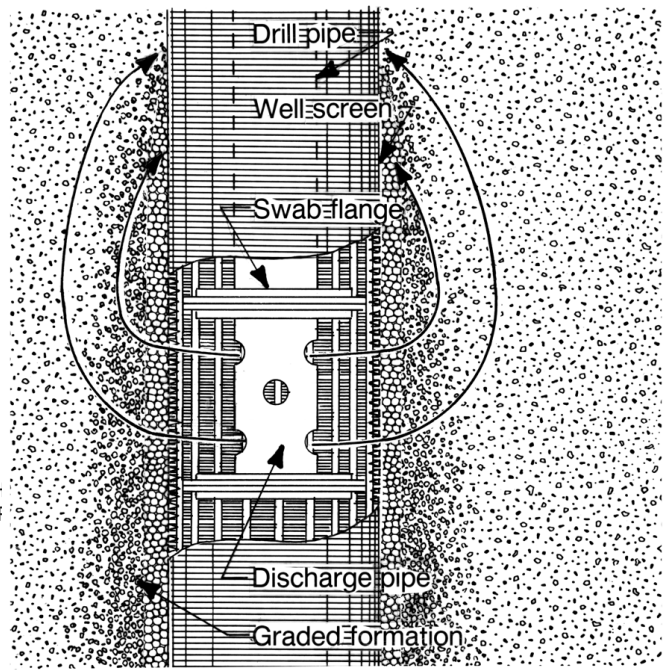
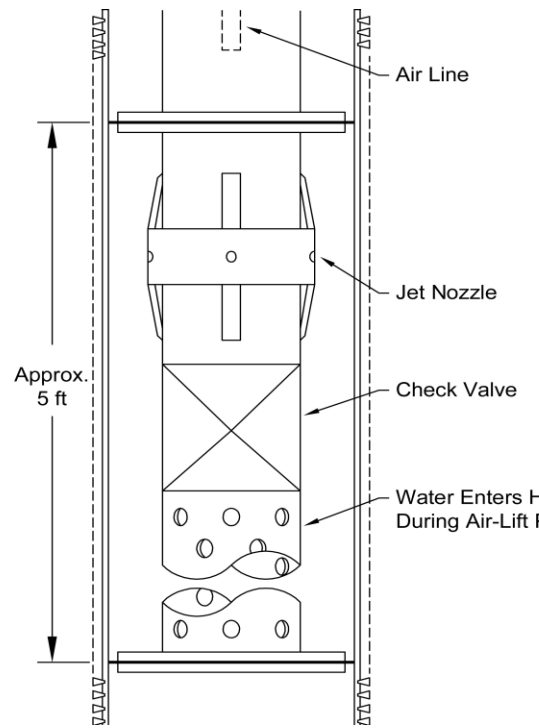



# Air Lift Development

- ❑ Surging with an aerated column of water using an eductor pipe
- ❑ Sand removal requires velocities of over 1,000 ft/min
- ❑ Pumping rates are a function of submergence, air volume, annular space, pumping lift and aquifer characteristics.

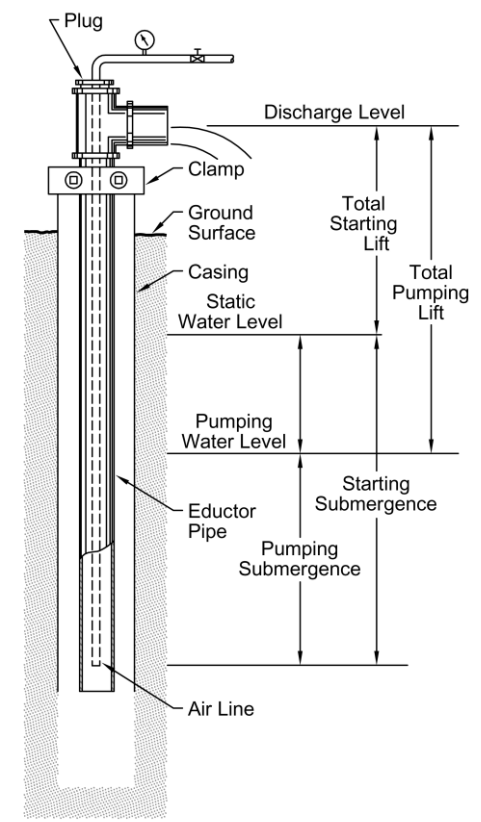

# Air Lift Pumping/Surging

- Develops most permeable zones.
- Better results when applied across the screen section.
- No pump required.
- Caution: can collapse casing/screen if premature.**





# Air Lift Pumping Chart

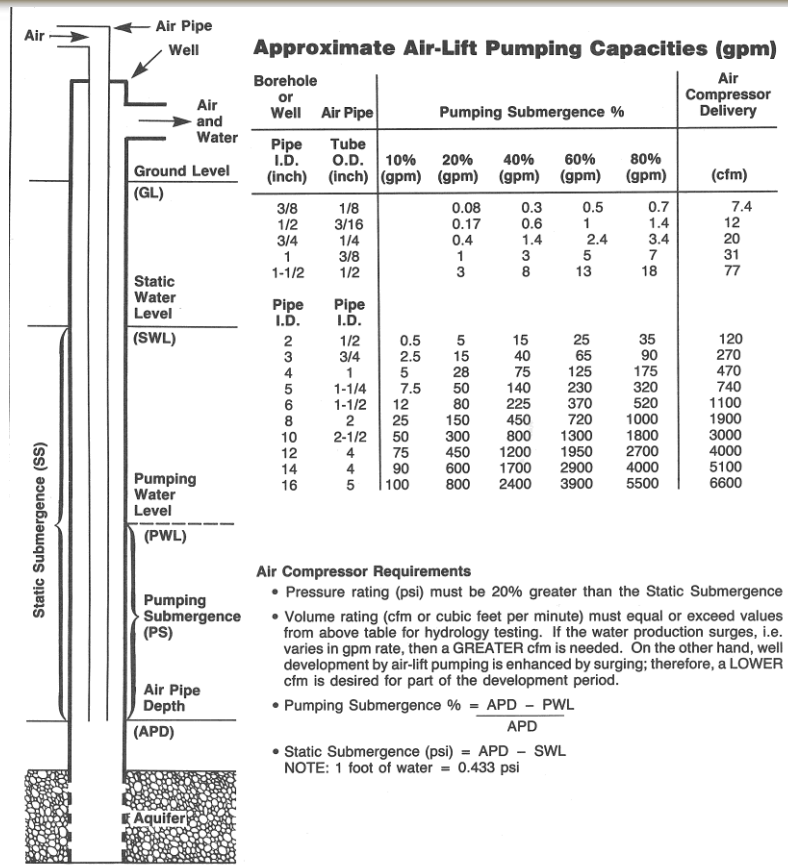

# Development Chemicals

- Chlorine:
  - Breaks most synthetic polymers
  - Breaks the polyacrylamides in most bentonites, improving removal.
- Surfactants / Wetting Agents
  - Improve penetration
- Phosphates should NOT be used as they promote biological growth.
- Almost always improve results and save time.



# When is a Well Developed?



# Components of Drawdown

$$S = S_l + S_n + S_e + S_w$$

Where:

$S$  = total drawdown

$S_l$  = head loss due to viscous drag of water moving through the aquifer with low laminar velocity.

$S_n$  = head loss due to non-laminar flow in the aquifer in the high-velocity region in the immediate vicinity of the well.

$S_e$  = head loss as the water exits the aquifer into the wellbore.

$S_w$  = head loss as the water flows within the wellbore to the pump intake.

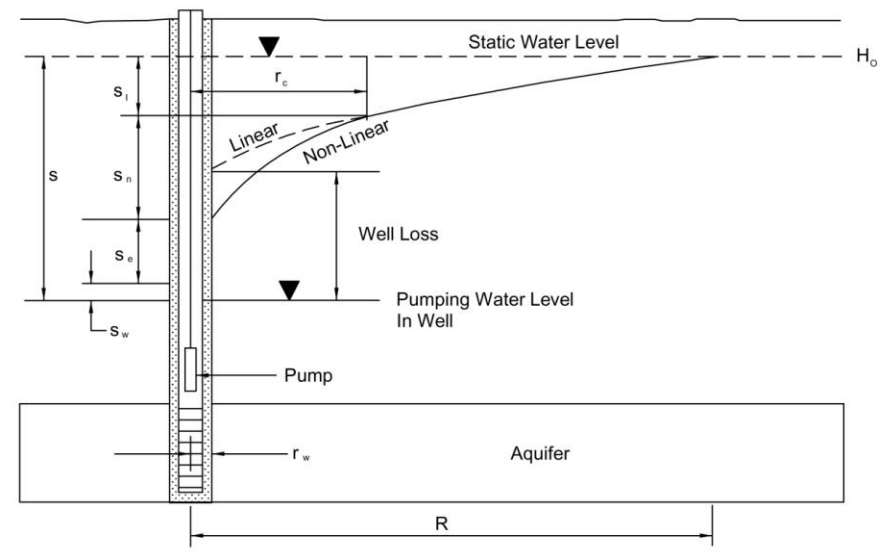

GWW-3<sup>rd</sup> Edition





# Before Development Gravel Pack Well

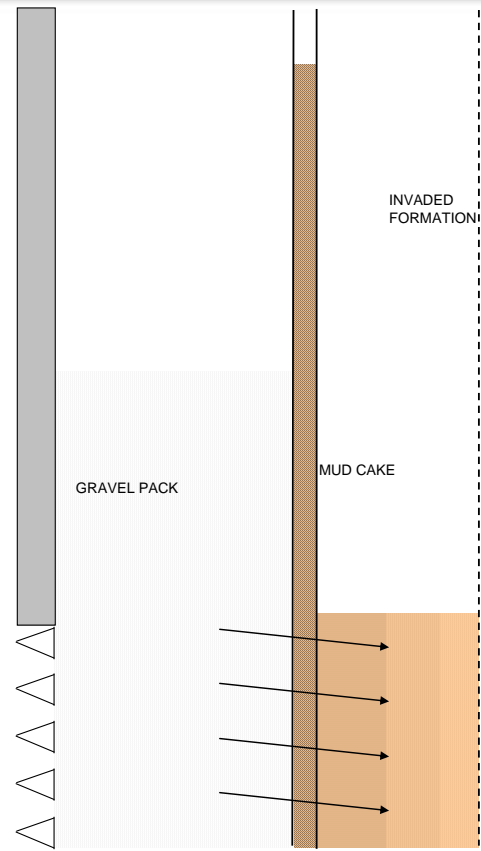

NATIVE FORMATION

INVADED FORMATION

GRAVEL PACK

MUD CAKE



# Well Losses Gravel Pack

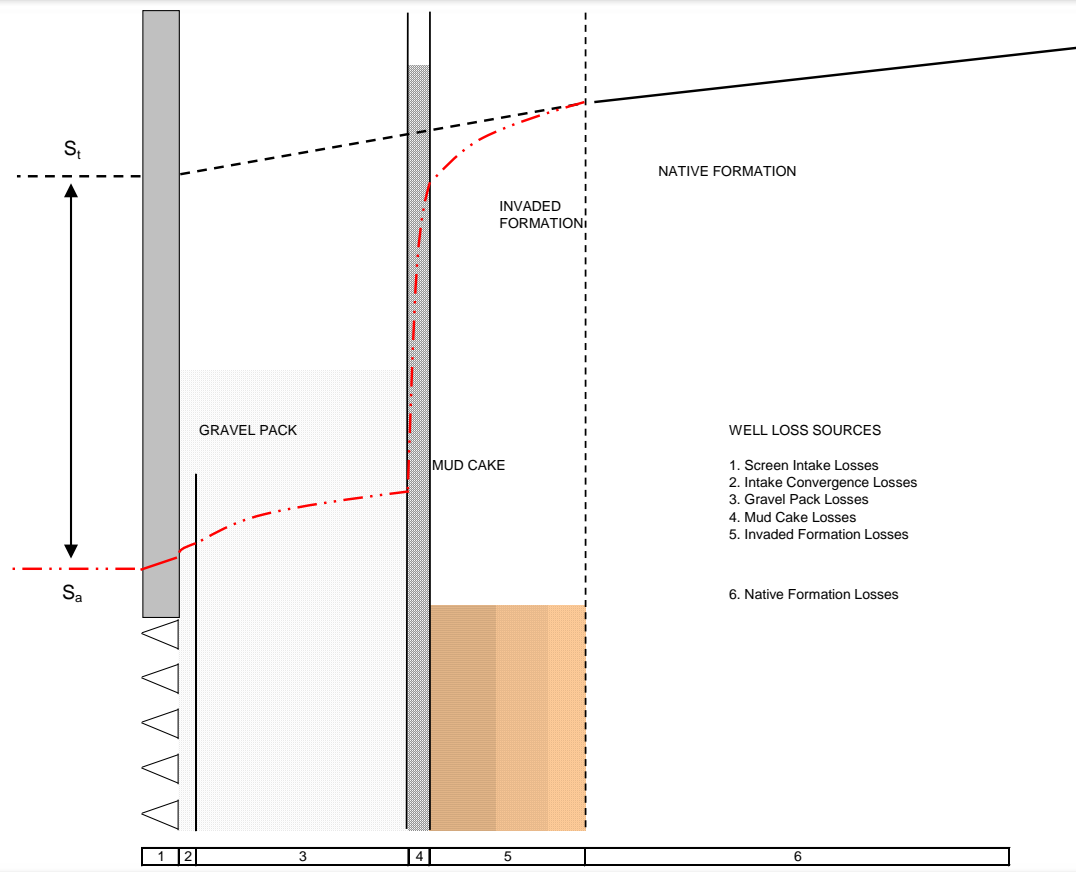



# Development Gravel Pack

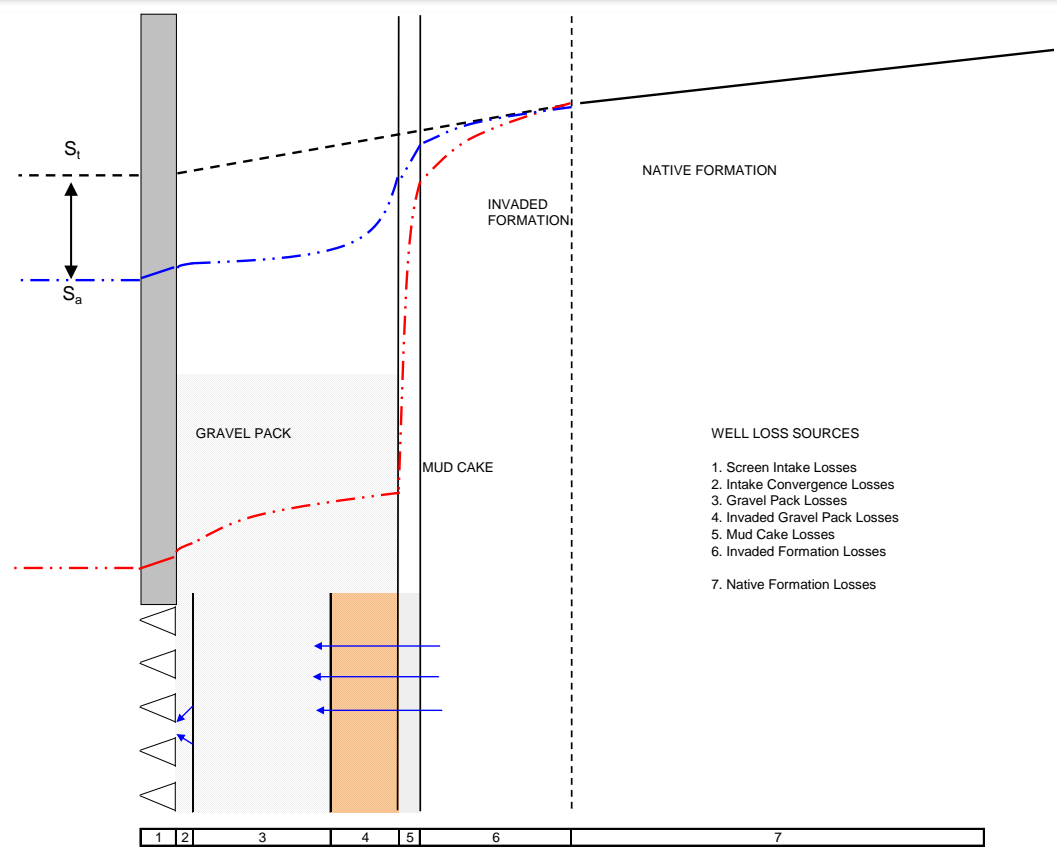

# Losses Non-Gravel Pack

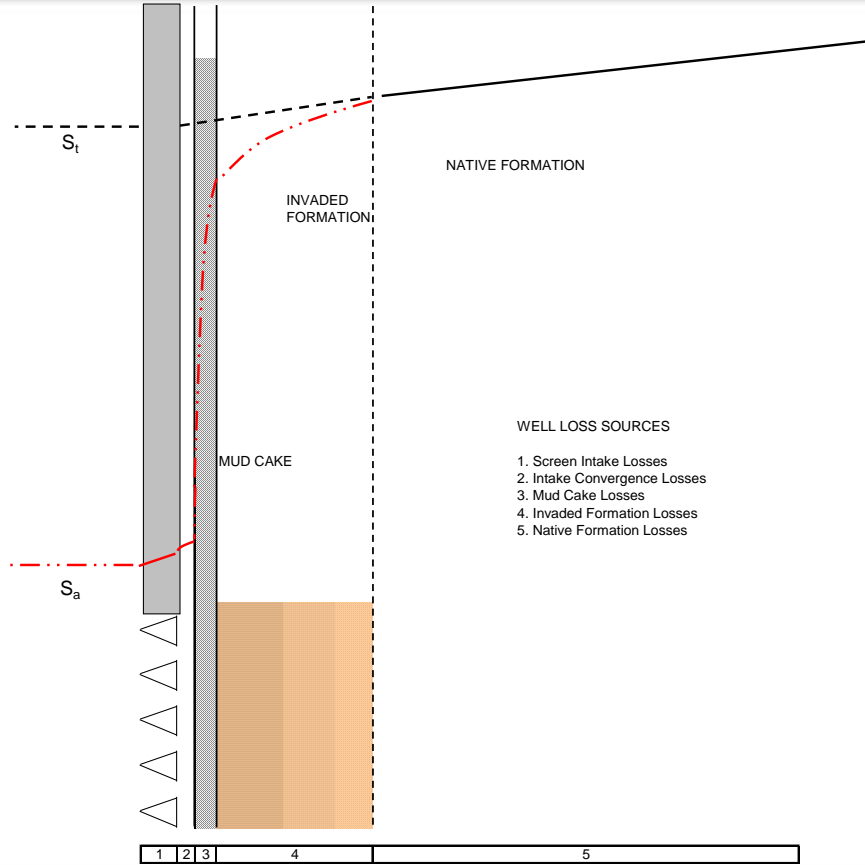

# Development Non-Gravel Pack

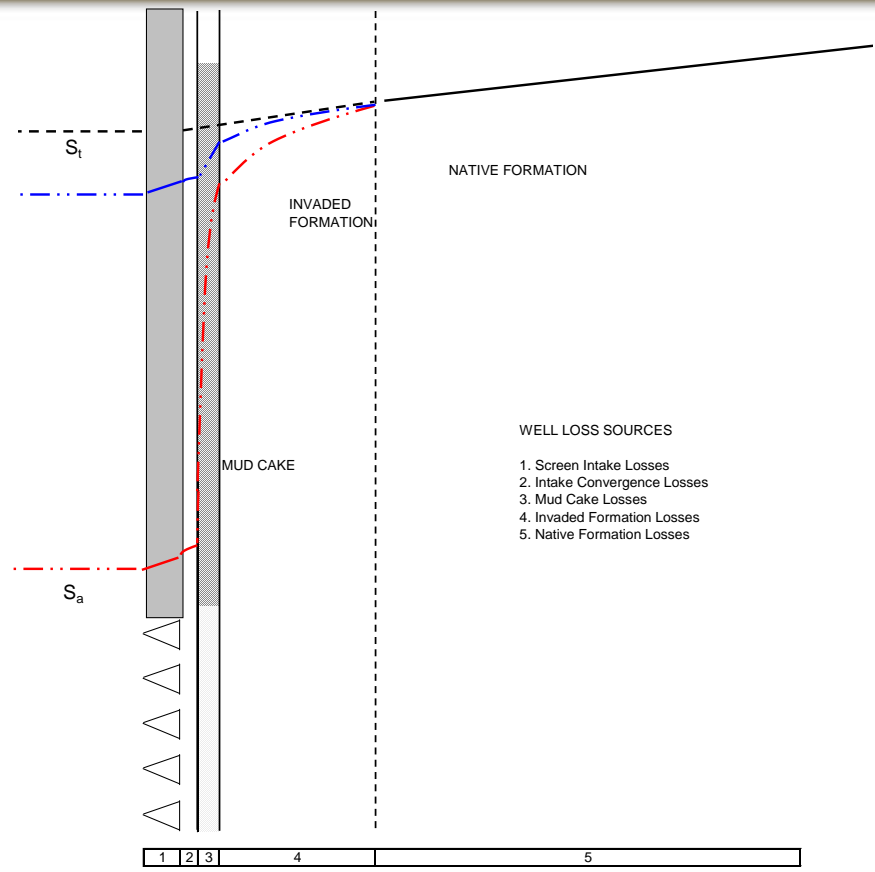



# When is a well developed?

- When contract terms are fulfilled?
- When turbidity is absent after agitation?
- When the *specific capacity* stabilizes?
- When predetermined efficiency is achieved?
- When no further improvement can be obtained in *specific capacity* and *efficiency* at a particular yield?



# Turbidity

10 ppm sand in 5-gal (19 liter) pail





# Specific Capacity & Efficiency

$$Sp\ Cap = yield / drawdown$$

$$E = \frac{\text{theoretical drawdown}}{\text{actual drawdown}} \times 100$$



# Drawdown Equations

$$s = \frac{264Q}{T} \log \frac{0.3Tt}{r^2 S}$$

*Cooper & Jacob (1946)*

$$s = BQ + CQ^2$$

*Jacob (1947)*

$$s = BQ + CQ^n$$

*Rorabaugh (1953)*

$$s = BQ + B''Q^n + CQ^2$$

*Williams (1985)*





# Well Efficiency

## An evaluation of drawdown

$$E_w = \frac{S_t}{S_a}$$

$$E = \frac{Q / s_{\text{actual}}}{Q / s_{\text{theoretical}}} \times 100$$

$$E = \frac{BQ}{(BQ + B'Q + B''Q^n + CQ^2)} \times 100$$





# Cost to Pump

$$KW = \frac{Q \times (S + SWL) \times 746}{3960 \times E_o}$$

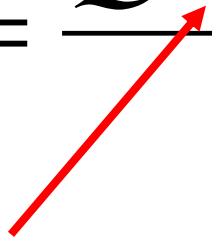

Drawdown





# Real Results

Staples Minnesota  
City San Antonio, TX  
Shageluk, AK  
Confluence Lake, Delta CO





# Staples Study

In early 1980's the Division of Energy Conservation of the US Department of Energy began a \$1.5 million study to improve irrigation energy-efficiency.

Part of this study was a well-efficiency project at the Irrigation Research Center near Staples, Minnesota affiliated with the Extension Division of the Agricultural Engineering Department of the University of Minnesota.

Six wells were completed in close proximity, all drilled by rotary method in glacial alluvium. Three drilled with bentonite, three with Revert (biodegradable polymer). Two completed with mill-slot pipe, two with bridge louvers, two with continuous slot screens. All were developed and tested alike.





# Overview of Staples Project

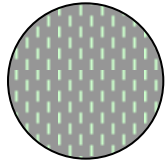

Mill Slot

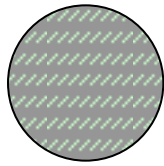

Bridge/Louver

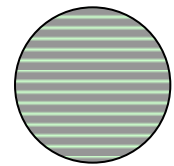

Wire Wrap

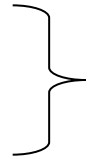

Bentonite

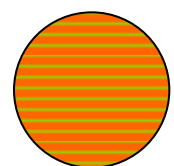
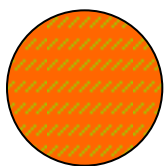
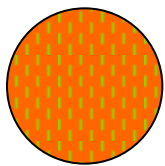

Revert

Each well developed by:

- 1. Over-pumping
- 2. Surging
- 3. Jetting w/Air Lift

Test Pumped after each step.



# Staples Study - Findings

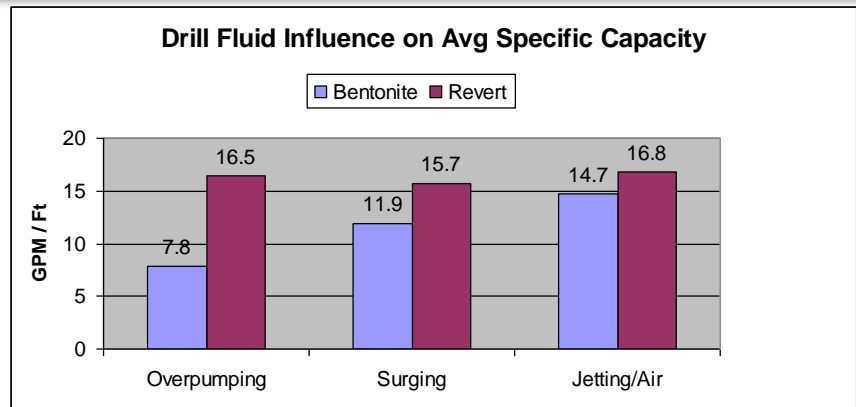
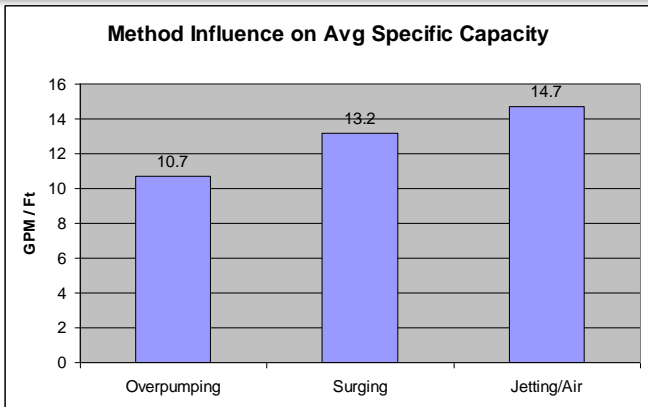

1. Aggressive mechanical agitation resulted in overall average S.C. increase of 23%.
2. Wells drilled with polymer drill fluid (Revert) yielded 24% higher S.C. on average.
3. Intakes with > 15% open area had average S.C. 52% higher than those with < 15% OA.

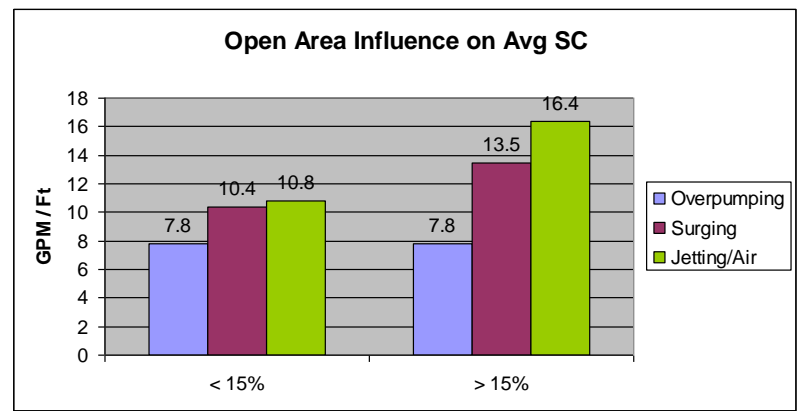



# San Antonio Wells

To meet the minimum well efficiency, construction records for three conventional gravel pack wells completed at the site indicated the average development time was approximately 1 hours per foot of screen.

MuniPak was considered and accepted for installation.





# San Antonio Water Systems

## Pumping Rate 1,400 gpm (~ 90 liters/sec)

- 16x18 inch MuniPak in 20-inch borehole (406mmx457mm / 508 mm BH)
- DD = 24.1 Ft (7.3 meters)
- SC = 58 GPM/Ft (12.1 l/s-m)
- 16-in rod base screen packed in 24 inch borehole (406mm / 610mm)
- DD = 30.5 Ft (9.3 meters)
- SC = 46 GPM/Ft (9.5 l/s-m)





# San Antonio Conclusions

- Borehole diameter was reduced 16% (from 24 to 20 inch)
- Development time fell 37% (from 0.95 to 0.60 hr/ft-screen)
- Drawdown decreased 21% (from 30.5 to 24.1 ft)
- Specific Capacity increased 26% (from 46 to 58 gpm/ft)







# Shageluk, AK

27 July 2009

## MONITOR / SUPPLY WELL

### Well Description:

- TD = 110-ft (34 m), BH = 7-7/8" (200mm)
- 8" (203mm) Pitless ~ 10-ft (3 m)
- 6" (152mm) Sch40 PVC 10-93ft (28 m),
- K-packer into pitless.
- 6" (152mm) 20 slot (0.5mm) SS screen to 103ft (31 m)
  
- Geology: coarse sand&gravel w/clay
- Lost circulation





# Shageluk, AK

- ❑ Drilling comments: stopped frequently to test; had to shove screen to final TD.
- ❑ Initial Development: bailer surged with *Aqua Clear*, pumped w/4" (102mm) submersible, < 1 GPM (0.06 l/s) flow
- ❑ Treatments: Displaced 1500+ ppm chlorine solution; soaked 12-24 hours (twice); surged w/modified bailer tool before evacuating each chlorine bath; effluent continued to yield turbidity.
- ❑ Improvement gauged by continuous yield of turbidity and faster recovery times.
- ❑ Final cycle pumping cleared the well; final yield was ~ 6 GPM (0.4 l/s) as originally anticipated.
- ❑ Total of 10 calendar days / achieved 6 fold increase.





# Confluence Lake, Delta, CO

- ❑ 12" (305mm) Water source wells for fishery.
- ❑ Drilled dual wall percussion method; 18" (457mm) temp casing; 12" (305mm), 125 slot (3.2mm) SS screen, 12" (305mm) LCS casing installed, 1/4" x 1/2" (6.35mm x 12.7mm) gravel packed and 18" temp casing withdrawn.
- ❑ Geology: alluvial riverbed gravel, sand, silt and clay approximately 40-ft (12 m) thick.
- ❑ Theoretical Yield: estimates were 380 to 440 GPM (~ 25 liters/sec).

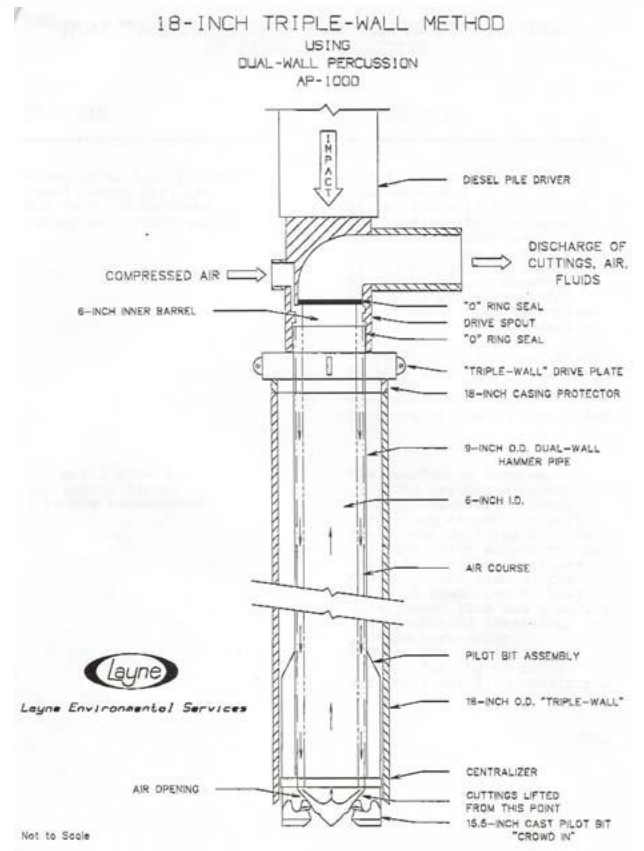



# Confluence Lake

- ❑ Initial Development: airlifting 4-hours until discharge was free of sediment. Test pump installed and well surged 4 additional hours. (Poor production noted during this pumping.)
- ❑ Initial Step Test: (conducted at 50, 100, 150 GPM – 3, 6, 9 l/s) indicated poor initial yields at less than ½ anticipated.
- ❑ Formation Damage: Even though drill mud was not used, engineers concluded liquefaction of formation can occur adjacent to the casing due to formation vibration. The bottom-hole airlifted cuttings causes depressurization at the bottom of the borehole and (the liquefied) fine grained sediments moved toward the outer casing by moving from areas of higher pressure to lower pressure resulting in formation damage. This resulted in the need for further development.
- ❑ Secondary Development: Johnson's NW-220 Clay Dispersant was swabbed into the formation and surged for 6 hours and airlift pumped for 2 hours until the discharge was sediment free. (Clays & silts were removed that were not noted during initial development.
- ❑ Final Step Test: (conducted at 100, 200, 300 GPM – 6, 13, 19 l/s) yields that were originally anticipated.





# Why is Development Important?

- ❑ Determines a successful (unsuccessful) completion
- ❑ Impacts Quality
  - ❑ Michigan study concluded wells properly developed had fewer problems with positive coliform tests. (Schneider 2003).
- ❑ Has major impact on yield, S.C., efficiency.
- ❑ Financial impact / Operational cost
- ❑ Useful Well Life



Development is an investment in efficiency.  
Don't take short cuts!  
It's what makes the HOLE a WELL.

*Thank you for your patience!*





# National Ground Water Research and Educational Foundation



*Your vital and integral resource for ground water's future*

Established in 1994, the National Ground Water Research and Educational Foundation is operated by the National Ground Water Association as a 501(c)(3) public foundation and is focused on conducting educational, research, and other charitable activities related to a broader public understanding of ground water.

The Foundation is an arm of NGWA that is focused on activities related to a broader understanding of ground water.





# National Ground Water Research and Educational Foundation

*Your vital and integral resource for ground water's future*

For more information visit us on the web at [www.ngwa.org](http://www.ngwa.org)  
or write us at the below address.

NGWREF  
601 Dempsey Road  
Westerville, OH 43081  
Phone/ 614-898-7791  
Fax/ 614-898-7786

Email/ [ngwref@ngwa.org](mailto:ngwref@ngwa.org)

